

Manual Pressure Scout

SignalFire Model: Scout-PSIx-1BIS



The SignalFire Pressure Scout is an Intrinsically Safe wireless pressure sensor with the following features:

- Powers integrated pressure sensor and radio for years with an internal battery
- Rapid pressure sampling with configurable alarms and report by exception
- Available in standard pressure ranges
- Pushbutton or remote zeroing
- Sends data to a SignalFire Modbus Gateway
- Compact and simple to install and maintain
- AES 128bit Encryption

Specifications

Enclosure Size	7.25" tall × 2.75" diameter
Power Source	Internal IS Lithium battery pack SignalFire Part Number: 1BIS
Temperature Rating	-40°C to +60°C
Radio Frequency	902-928MHz Ism Band, FHSS radio, internal antenna FCC ID: W8V-PS IC: 8373A-PS
Compliance	Certified for use in Class I, Division 1 groups C and D. T3 EXi [EXi] FCC/IC Certified. UL 913:2013 Ed.8, CSA C22.2#157:1992 Ed.3



WARNING: Use of this equipment in a manner not specified by the manufacturer may impair the protection provided by the equipment.

AVERTISSEMENT: L'utilisation de cet équipement d'une manière non spécifiée par le fabricant peut nuire à la protection fournie par l'équipement.



WARNING: The use of any parts not supplied by the manufacturer violates the safety rating of the equipment.

AVERTISSEMENT: L'utilisation de pièces non fournies par le fabricant est contraire à la cote de sécurité de l'équipement.

Refer to control drawing 960-0081-01 for requirements when used in a Class I Division 1 area.

Reportez-vous à l'illustration de contrôle 960-0081-01 pour connaître les exigences lorsqu'elle est utilisée dans une zone de classe I division 1.

SignalFire Pressure Scout

Models: Scout-PSIx-y

x=pressure span, y=power source

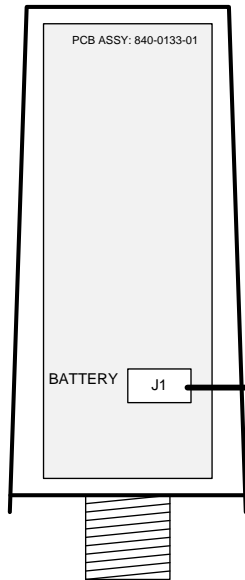

Power Source	
Ui/Vmax:	5.9 VDC
Ii:	3.1 A
Pi:	0.89 W
Ci:	9.66 uF
Li:	0.1 uH

<h2>SignalFire Telemetry</h2>	
Part Name	Control Drawing, Pressure Scout
Date	10/10/16
Part Number	960-0081-01
Rev	1.1
Page 1 of 1	

Class I, Division 1, Groups C and D	Ambient Temperature Limit: -40C to +60C Temperature Code: T3
<ul style="list-style-type: none"> • WARNING: Substitution of components may impair intrinsic safety. • Choose peripheral devices and associated apparatuses such that the following conditions are met: $U_i/V_{max} \geq U_o/V_{oc}$ $I_i/I_{max} \geq I_o/I_{sc}$ $P_i \geq P_o$ $C_o/C_a \geq C_i + C_{cable}$ $L_o/L_a \geq L_i + L_{cable}$ • When replacing the internal battery, only use SignalFire lithium battery model number 810-0030-01 (1BIS) • See SignalFire instruction manuals numbers 960-0082-01 for installation requirements • Install the internal battery pack only when external power is not used 	

Connections and Components

Radio LEDs

- The Radio TX LED (**green**) flashes each time a radio packet is sent. This LED will blink rapidly while searching for the radio network and at boot up.
- The Radio RX LED (**red**) blinks on each received radio packet.

Status LEDs

- The STATUS LED (**green**) will blink on when the pressure sensor is sampled.
- The ERROR LED (**red**) will blink to indicate an error condition.

Checkin Button

- If this button is pressed the Scout will take a reading from the integrated pressure sensor and send the data to the gateway.

Zero Button

- Allows the pressure sensor to be zeroed. Hold the 'Zero' button down for 3 seconds to zero the pressure sensor. The status LED will come on and then blink twice to indicate that the sensor has been zeroed.

Setup

The Pressure Scout needs to be set up for correct operation before being fielded. The configurable items include:

- Network selection
- Check-in period selection
- Modbus Slave ID setting
- Optional alarm thresholds and scaling

All settings are made using the SignalFire Toolkit PC application and a USB-serial programming cable available from SignalFire. The USB-4Pin cable has 5 positions on it, but only 4 are populated with wire. Make sure that the 4 positions with conductors connect to the 4 pins on the Pressure Scout.



WARNING: Perform the steps in this section (Setup) in a safe location only.

AVERTISSEMENT: Suivez les étapes de cette section (Configuration) dans un endroit sûr uniquement.

Using the SignalFire Toolkit

The SignalFire Toolkit application can be downloaded at www.signal-fire.com/customer. After installation, launch the software and the main toolkit window will open:

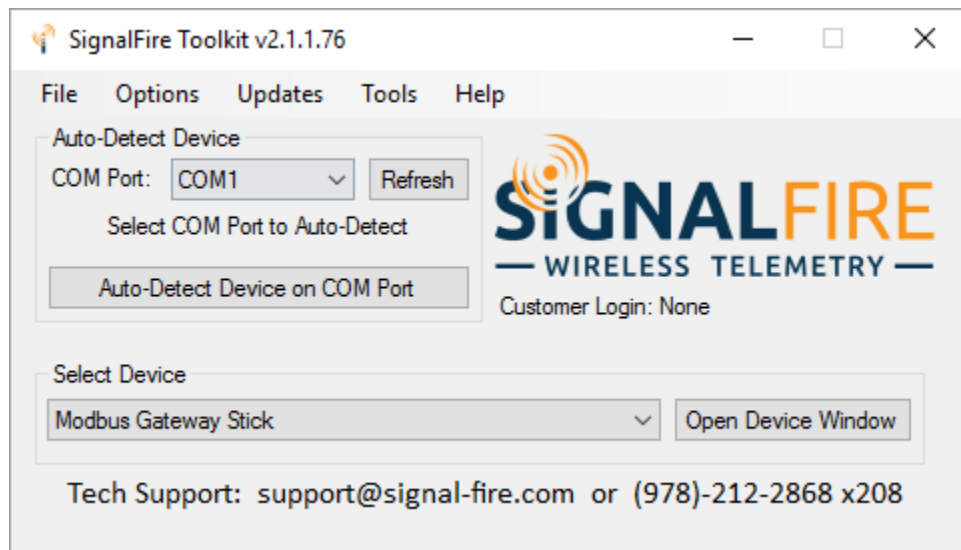

Select the COM port associated with the Pressure Scout and click "Auto-Detect Device on COM Port." This will open the device configuration window, where all device settings can be configured.

The screenshot shows the Pressure Scout software interface. At the top right, the 'Radio State' is 'Connected -31dBm' (9). The interface is divided into several sections:

- Serial Port Settings (1):** Includes a dropdown for 'COM Port' set to 'COM13', a 'Refresh' button, and 'COM13 Open' (1) and 'Open' (2) buttons.
- Scout Information (2):** A table showing product details: Product (Pressure Scout), Mainboard Version (0.85), Radio Version (2.50 (sleeping)), and Radio Address (38455).
- Radio Settings (3):** Includes 'Radio Network' (6), 'Radio Network Group' (5), 'Enable Encryption' (checked), and a 'Key' field with 'scorpion'.
- Device Settings (4):** Includes 'Slave ID' (15), 'Node Name' (5H_Casing), and 'Checkin Interval' (1 minute).
- Scale Settings (5):** Includes 'Scaling Type' (Custom), 'Scale Low Value' (0), 'Scale High Value' (20.5), and 'Scale Offset (+/-)' (0).
- Alarm Threshold Settings (6):** Includes 'ALARM Settings' with 'Low' (20 PSI) and 'High' (3200 PSI) checked, and 'Sample Interval' (5 seconds).
- Battery Life Estimate (7):** Shows '6.7 years (Based on new battery.)'.
- Modbus Register Values (8):** A table with columns 'Address', 'Description', and 'Value'. It lists various sensor and alarm values.
- Connection Status (9):** Located at the top right, showing 'Radio State: Connected -31dBm'.

At the bottom left, it says 'Running report...'. A large number '6' is visible on the right edge of the image.

- | | | | |
|---|-----------------------|---|--------------------------|
| 1 | Serial Port Settings | 2 | Scout Information |
| 3 | Radio Settings | 4 | Node Device Settings |
| 5 | Custom Scale Settings | 6 | Alarm Threshold Settings |
| 7 | Battery Life Estimate | 8 | Modbus Register Values |
| 9 | Connection Status | | |

Network Setting

The network is set using the SignalFire Toolkit. The network, network group, and corporate ID/encryption key settings must match those of the gateway for them to communicate. When any setting is changed, it will be highlighted yellow, indicating it has not actually been written to memory. To apply the desired settings, click the **Apply All Settings** button in the upper left hand corner, as indicated by the red box in the figure above.

Encryption

To protect your over-the-air data and prevent tampering, SignalFire networks come with encryption. Legacy products use a Corporate ID, but can be switched over to use an encryption key if the firmware and ToolKit are up to date.

To set up a legacy Pressure Scout to use encryption, click the checkbox labeled **Enable Encryption** inside the **Set Corporate ID** box. All newer Sentinels come with this option enabled with "signalfire" as the default encryption key.

The screenshot shows the 'RADIO Settings' dialog box. It contains two dropdown menus: 'Radio Network' set to 6 and 'Radio Network Group' set to 5. Below these is an unchecked checkbox labeled 'Enable Encryption' with a 'Help' button to its right. At the bottom, there is a text field labeled 'Corporate ID:' containing the value '118'.

Corporate ID

The screenshot shows the 'RADIO Settings' dialog box. It contains two dropdown menus: 'Radio Network' set to 6 and 'Radio Network Group' set to 5. Below these is a checked checkbox labeled 'Enable Encryption' with a 'Help' button to its right. At the bottom, there is a text field labeled 'Key:' containing the value 'scorpion'.

Encryption Enabled

The box will then change into a **Set Encryption Key** box, and it will prompt instead for the encryption key you would like to use. Note that keys may not contain spaces or angle brackets. If you are setting up a new network, you will need to set the encryption key on all your devices. If you are adding a Pressure Scout to a legacy network, you can simply set the Corporate ID without clicking the Enable Encryption box, and it will remain compatible with the older system.

It is also possible to hide your encryption key so it cannot be read. This is the most secure option, but if you forget your key, there is no way to recover it – you must reset the key on every device on its network. To enable this option, select **Set Encryption Key Unrecoverable** under the **Settings** menu.

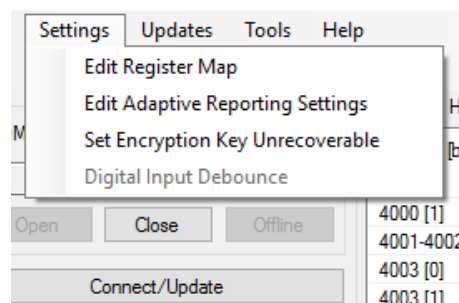

Setting the encryption key to be unrecoverable.

Modbus Slave ID

The Modbus Slave ID can be set with the SignalFire Toolkit. Each remote device connected to the gateway must have a unique Modbus Slave ID (1-240). Every SignalFire device must have a unique slave ID to prevent conflicts.

Alarm Threshold Settings

Optional alarm threshold settings are available which allow for rapid pressure sample interval (5 or 15 seconds) and will cause the Pressure Scout to check-in immediately if the threshold is crossed. While above the high alarm threshold (or below the low alarm threshold) the Scout will checkin at the configured sample interval. The Low and High alarm thresholds can be enabled individually.

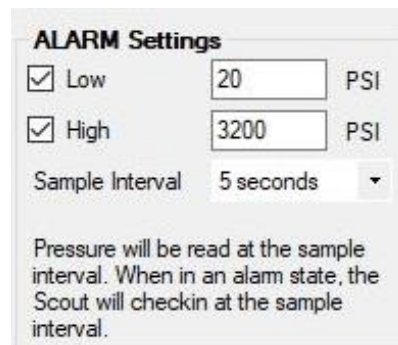

The screenshot shows a configuration window titled "ALARM Settings". It contains the following elements:

- A checked checkbox for "Low" with a text input field containing "20" and the unit "PSI".
- A checked checkbox for "High" with a text input field containing "3200" and the unit "PSI".
- A "Sample Interval" label followed by a dropdown menu showing "5 seconds".
- A paragraph of text: "Pressure will be read at the sample interval. When in an alarm state, the Scout will checkin at the sample interval."

Setting the alarm thresholds.

Custom Scaling

The reported pressure can be optionally scaled to a custom range. This can be used to scale PSI to inches of H2O for example. If custom scaling is enabled, a Scale Low Value and Scale High Value must be configured. In addition, an optional Scale Offset can be set. The Scale Offset will be added (or subtracted) to the reported scaled value.

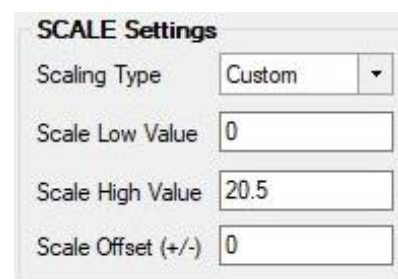

The screenshot shows a configuration window titled "SCALE Settings". It contains the following elements:

- A "Scaling Type" dropdown menu set to "Custom".
- A "Scale Low Value" text input field containing "0".
- A "Scale High Value" text input field containing "20.5".
- A "Scale Offset (+/-)" text input field containing "0".

Setting custom scaling.

Pressure Sensor Zero Settings

Before installation, the pressure sensor should be zeroed out to correct for any electrical offset. The pressure sensor can be zeroed, via the Pressure Sensor Zero pull-down menu, or the "Zero" button on the Scout's front panel.

Leave the Pressure Scout open to atmospheric pressure (0PSI gauge). To zero without the ToolKit, simply hold the "Zero" button down for 3 seconds until the "ACT" light turns solid, and the Pressure Scout will apply a baseline offset.

To view the baseline zero offset, or to set the zero offset through the ToolKit, open the "Pressure Sensor Zero" window under the Settings tab. The current zero offset can be read back from the Pressure Scout, set with the "Zero Sensor" button, or erased.

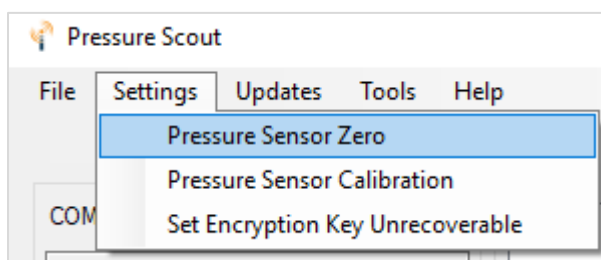

A negative deadband zone can be applied to the scaled floating point reading to remove small negative values. The default is "0". The deadband zone can be set in whole number increments which work as follows: Any negative reading within the defined "deadband" will be reported as zero. Any values below the deadband will be reported as the actual value. In the example below, any reading from 0PSI down to -2PSI will be reported as 0, and anything lower than -2PSI will be reported as the actual vacuum pressure.

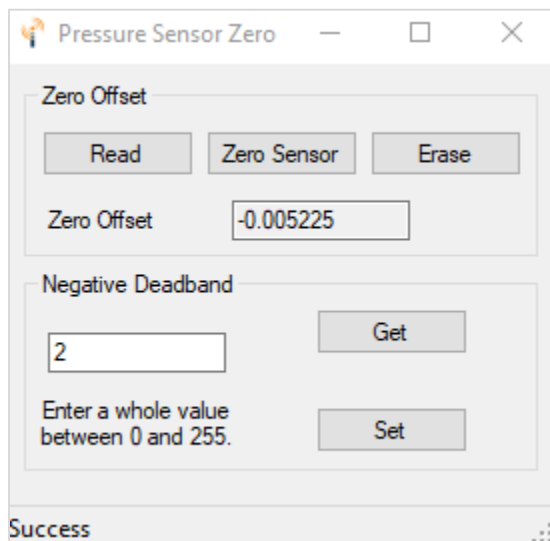

Zero Offset and Negative Deadband settings.

Pressure Sensor Calibration Settings

A gain factor can be applied to the sensor through the Pressure Sensor Calibration window, under the Settings drop-down menu. **Calibration should only be performed after first zeroing the sensor as shown above.**

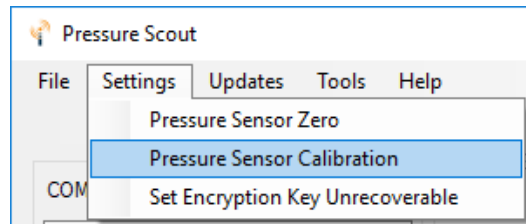

Calibration should be done with pressure applied to the Pressure Scout sensor. First, tie the sensor thread on the bottom to a pressure calibrator, or a line with a known stable pressure. Ideally, this pressure should be half the sensor span. For a 0-1,000PSI range Pressure Scout, for example, apply a stable 500PSI to the sensor.

Open the Pressure Sensor Calibration window. If calibration has not been performed, the "Current Gain Factor" will be set to 1. Otherwise, click "Clear Calibration" to start new. Once the calibrator pressure has been applied to the sensor, click "Sample Sensor". This value is how the sensor currently reads the applied pressure. Type the known pressure that the calibrator is actually outputting into the "Calibration Pressure" box, and click "Set Calibration."

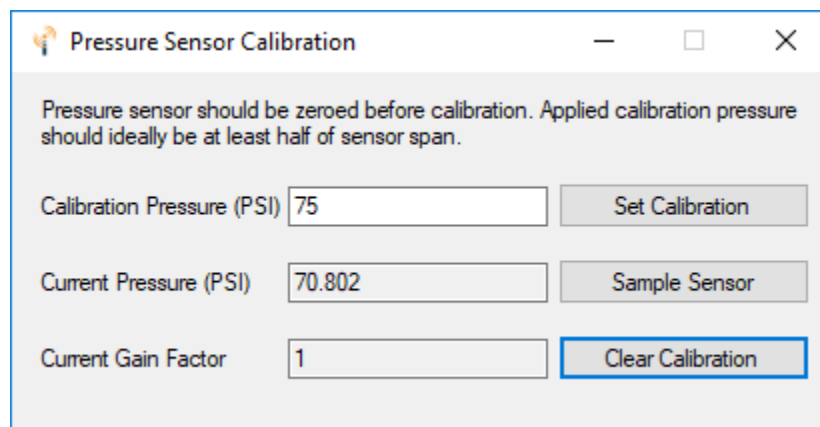

Pressure Sensor Calibration Settings

This will apply a linear gain factor to the sensor. Note that the ToolKit will not allow you to set calibration if the calibrator pressure is more than 10% off the initial sensor sample before calibration.

Offline Mode

11

Starting with firmware revision r0.88, an Offline Mode is implemented as a battery saving feature for cases when the Pressure Scout is unable to communicate with a Gateway.

If the configured check-in interval is less than 15-minutes, and the Pressure Scout cannot contact a Gateway for 2 consecutive hours it will enter "offline mode". In offline mode the Scout will back off and only attempt to scan for the gateway every 15-minutes.

This means that once a Scout enters offline mode, it will take it up to 15-minutes for the Scout to reconnect to a Gateway when the communication issue is resolved.

Examples that would cause a Scout to enter offline mode include if it is powered up and installed prior to the Gateway being installed, or if the Gateway were to go offline due to loss of power or other failure.

Remote Modbus Register Mapping

The Scout Node sends data to a SignalFire Telemetry Modbus Gateway. The data that is sent to the gateway is available at the gateway in registers where it can then be read by a Modbus RTU. Consequently, the node needs to have a unique (to the network it is in) Modbus slave ID which the gateway will use to store its unique data.

Modbus Registers

Every check-in period, the sensors are read and data is sent to the gateway. The gateway will save the data under the set Modbus ID in 16-bit registers. The register map for this system is below.

Register Map

Register Number	Register Address (Offset)	Description
43001	3000	Sensor Voltage (mV) (500mV to 2500mV is normal range)
43002	3001	Sensor PSI Reading (int)
43003	3002	Sensor PSI Reading x 100 (int) (only valid for pressures up to 650psi)
43004	3003	High Alarm Notification (0 = no alarm, 1 = high alarm active)
43005	3004	Low Alarm Notification (0 = no alarm, 1 = low alarm active)
43006	3005	Low Battery Alarm (0 = battery above 3.0V, 1 = battery below 3.0V)
43007	3006	Sensor Span (PSI)
43008	3007	Sensor Error Status (0=no errors, 1=sensor out of range low, 2=sensor out of range high)
43009-43010	3008-3009	Sensor PSI Reading (float)
43011-43012	3010-3011	Custom Scaled Sensor Reading (float)
43013-43014	3012-3013	Alarm High Threshold Setting (float)
43015-43016	3014-3015	Alarm Low Threshold Setting (float)
49987	9986 or 65523	Low Battery Alarm (0 = battery above 3.0V, 1 = battery below 3.0V)
49988	9987 or 65524	Major revision number for the mainboard
49989	9988 or 65525	Minor revision number for the mainboard
49990	9989 or 65526	Major revision number for the radio
49991	9990 or 65527	Minor revision number for the radio
49992	9991 or 65528	High 16 bits of SFTS node address
49993	9992 or 65529	Low 16 bits of SFTS node address (the radio ID)
49994	9993 or 65530	Slave ID readback
49995	9994 or 65531	Received signal strength of last packet from the slave
49996	9995 or 65532	Battery voltage of the Modbus client, in millivolts
49997	9996 or 65533	Minutes until this slave will time out, unless new data is received
49998	9997 or 65534	Number of registers cached for this slave device
49999	9998 or 65535	Remote device type. 56 for Pressure Scout

Mounting and Care

The Pressure Scout unit comes with an integrated pressure sensor with a ½" MNPT process fitting. The Scout is mounted directly to the pressure source. It is important to mount the Scout so it is vertically orientated with the pressure fitting facing down.



WARNING: The Pressure Scout must be mounted in a location free of high vibrations. Over time vibrations can damage the Sentinel or battery pack, which could impair its safety ratings. Do not mount directly to continuous vibrating equipment such as pumps or compressors.

The Pressure Scout should be mounted vertically.

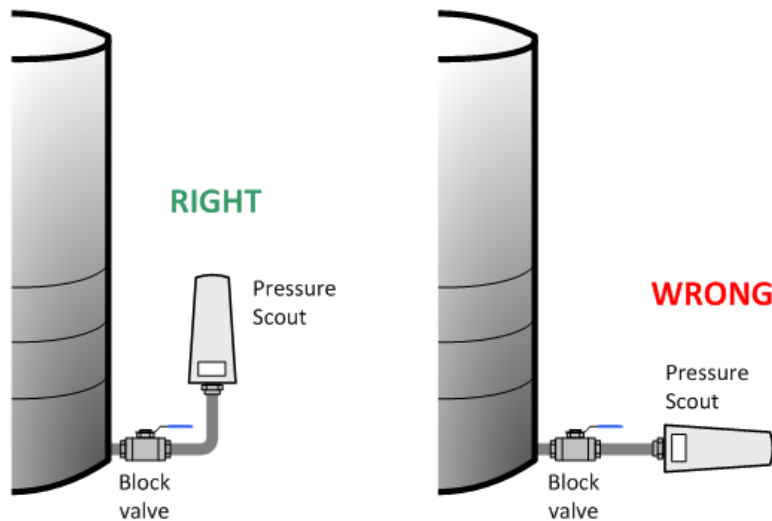

How you install the Pressure Scout may also depend on the process fluid. Refer to the diagram below for installation on gas, steam, or liquid.

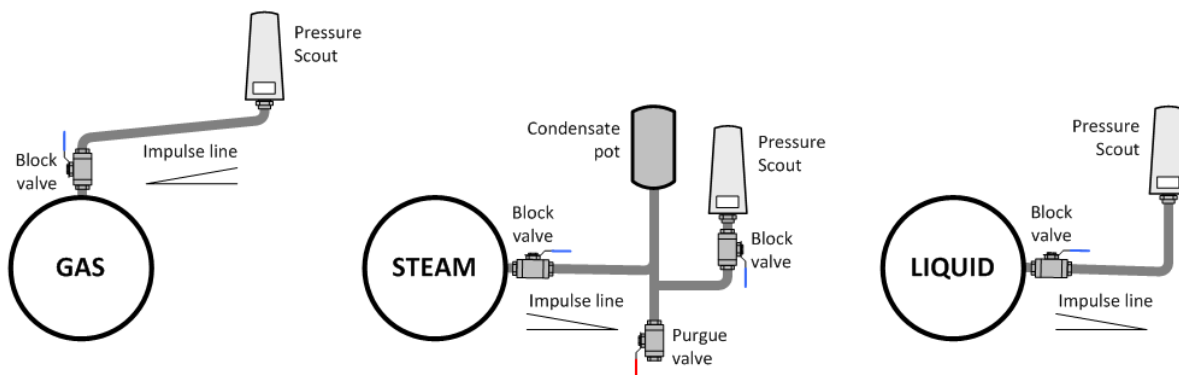

Internal Lithium Battery Replacement

Battery Packs can be changed with the node in place.

1. Unscrew the cover from the base.
2. Unplug the battery from the PCB, by depressing the locking clip on the connector.
3. Remove/replace battery
4. Connect the battery to the main PCB battery connector.
5. Install the enclosure cover.



WARNING: Use of any battery other than the SignalFire part number 810-0030-01 (1BIS) will impair the protection provided by the equipment.

AVERTISSEMENT: L'utilisation d'une pile autre que la référence SignalFire 810-0030-01 (1BIS) compromettra la protection fournie par l'équipement.

Cleaning Instructions

The outside of the enclosure may be cleaned with water, mild soap, and a damp cloth as needed. High pressure washing is not recommended.



WARNING: Electrostatic Discharge Hazard! Care must be taken to avoid the potential of creating a change on the enclosure or antenna. Do not wipe with a dry cloth. Do not brush against the enclosure with clothing or gloves.

AVERTISSEMENT: Risque de décharge électrostatique! Il faut veiller à éviter tout risque de changement de l'enceinte ou de l'antenne. Ne pas essayer avec un chiffon sec. Ne pas brosser contre l'enceinte avec des vêtements ou des gants.

Configuration / Debug



WARNING: Only connect to the debug port in a safe area!

AVERTISSEMENT: Se connecter uniquement au port de débogage dans une zone sûre!

Debug and configuration information is available if a connection is made via the debug port on the main board. A USB converter cable (USB-Serial-4PIN, available from SignalFire) must be used for this interface.

Debug and advanced configuration may be done using the SignalFire Toolkit PC application.

Technical Support and Contact Information

SignalFire Telemetry
140 Locke Dr., Suite B
Marlborough, MA 01752
(978) 212-2868
support@signal-fire.com

Revision	Date	Changes/Updates
1.0	10/1/16	Initial release
1.1	10/10/16	Updated control drawing, Edits to register map
1.2	11/8/16	Added French translations for warnings
1.3	9/14/17	Updated warnings
1.4	11/27/17	Added Pressure Sensor Settings. Updated Custom Scaling screen shot.
1.5	12/12/17	Added Low Battery Alarm register 65523.
1.6	8/6/2018	Updated screenshots, calibration settings
1.7	1/10/20	Added detail about offline mode
1.8	5/19/20	Added graphics for mounting instructions

APPENDIX - FCC and IC Statements

16

Changes or modifications not expressly approved by SignalFire Telemetry, Inc could void the user's authority to operate the equipment.

This device complies with Part 15 of the FCC Rules. Operation is subject to the following two conditions: (1) this device may not cause harmful interference, and (2) this device must accept any interference received, including interference that may cause undesired operation.

This equipment has been tested and found to comply with the limits for a Class B digital device, pursuant to Part 15 of the FCC Rules. These limits are designed to provide reasonable protection against harmful interference in a residential installation. This equipment generates, uses and can radiate radio frequency energy and, if not installed and used in accordance with the instructions, may cause harmful interference to radio communications. However, there is no guarantee that interference will not occur in a particular installation. If this equipment does cause harmful interference to radio or television reception, which can be determined by turning the equipment off and on, the user is encouraged to try to correct the interference by one of the following measures:

- Reorient or relocate the receiving antenna.
- Increase the separation between the equipment and receiver.
- Connect the equipment into an outlet on a circuit different from that to which the receiver is connected.
- Consult the dealer or an experienced radio/TV technician for help.

WARNING!

FCC and IC Radiation Exposure Statement:

This equipment complies with FCC's and IC's RF radiation exposure limits set forth for an uncontrolled environment under the following conditions:

1. This equipment should be installed and operated such that a minimum separation distance of 20cm is maintained between the radiator (antenna) & user's/nearby person's body at all times.
2. This transmitter must not be co-located or operating in conjunction with any other antenna or transmitter.

Under Industry Canada regulations, this radio transmitter may only operate using an antenna of a maximum (or lesser) gain approved for this transmitter by Industry Canada. To reduce potential radio interference to other users, the antenna type and its gain should be so chosen that the equivalent isotropically radiated power (e.r.i.p.) is not more than that necessary for successful communication.

Conformément à la réglementation d'Industrie Canada, le présent émetteur radio peut fonctionner avec une antenne d'un type et d'un gain maximal (ou inférieur) approuvé pour l'émetteur par Industrie Canada. Dans le but de réduire les risques de brouillage radioélectrique à l'intention des autres utilisateurs, il faut choisir le type d'antenne et son gain de sorte que la puissance isotrope rayonnée équivalente (p.i.r.e.) ne dépasse pas l'intensité nécessaire à l'établissement d'une communication satisfaisante.

This device complies with Industry Canada licence-exempt RSS standard(s). Operation is subject to the following two conditions: (1) this device may not cause interference, and (2) this device must accept any interference, including interference that may cause undesired operation of the device.

Le présent appareil est conforme aux CNR d'Industrie Canada applicables aux appareils radio exempts de licence. L'exploitation est autorisée aux deux conditions suivantes : (1) l'appareil ne doit pas produire de brouillage, et (2) l'utilisateur de l'appareil doit accepter tout brouillage radioélectrique subi, même si le brouillage est susceptible d'en compromettre le fonctionnement.